



HIGH-END NMEA CONNECT PLUS GATEWAY

Use Cases



English version
01.05.2023

0. Index

1. Brief description of product and layout.

1.1 Brief description of product.

1.2 NCP High-End layout.

2. Use cases

2.1 How to display wind data from the NCP High-End via Wifi on PC Display from the Calypso Instruments Portable and Wired Ranges.

2.2 How to display wind data from the NCP High-End via Bluetooth or Wifi on Anemotracker App from the Calypso Instruments Portable and Wired Ranges.

2.3 How to display wind data from the NCP High-End via NMEA 2000 cable on a Raymarine display from the Calypso Instruments Portable and wired Ranges.

2.4 How to display wind data from the NCP High-End via NMEA 2000 cable on a B&B display from the Calypso Instruments Portable and Wired Ranges.

2.5 How to display data from the NCP High-End via NMEA 2000 cable on a Humminbird display from the Calypso Instruments Portable and Wired Ranges.

1. Brief description of product and layout

1.1 Brief description

The NMEA Connect Plus High-End (NCP- High End), can be connected to the Calypso Instruments Portable Range via **Bluetooth Low Energy (BLE)** and also to the Calypso Instruments Wired Range. The NCP High-End can also be forward connected to both NMEA 0183 and NMEA 2000 chartplotters, displays or NMEA backbones .

The diagram below outline the connection pathway:

Calypso Instruments Portable Range.

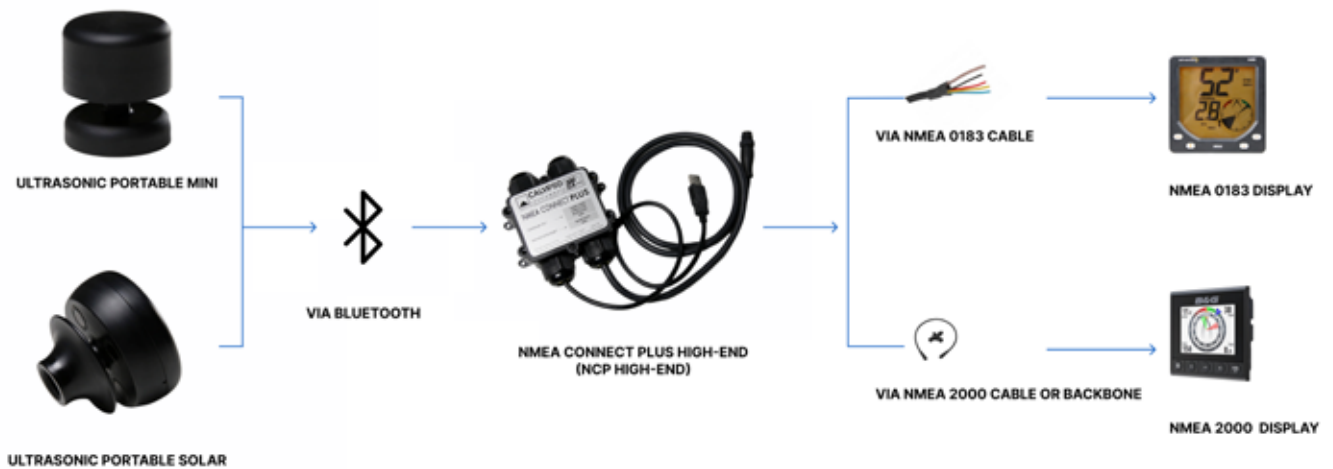

Calypso Instruments Wired Range.

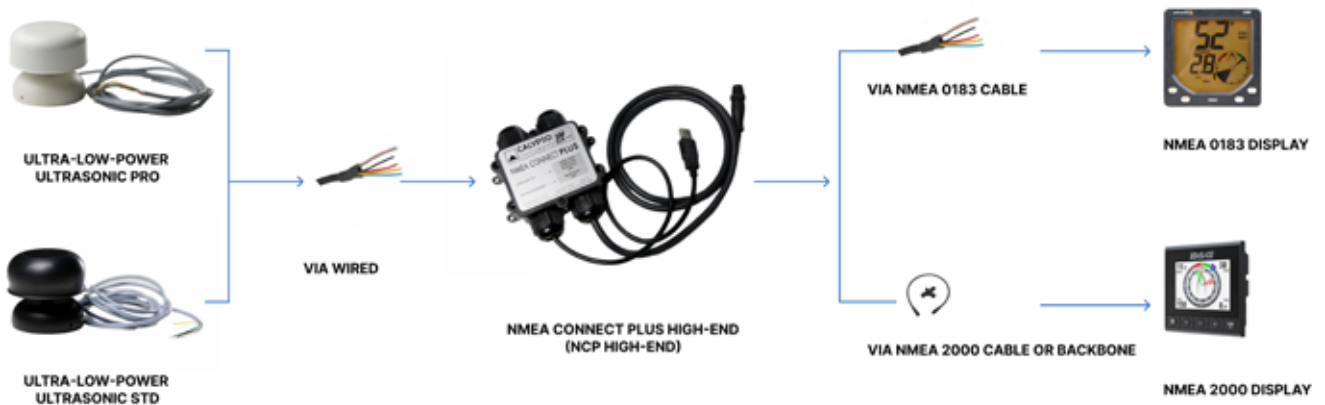

1. Brief description of product and layout

1.1 NCP High-End layout.

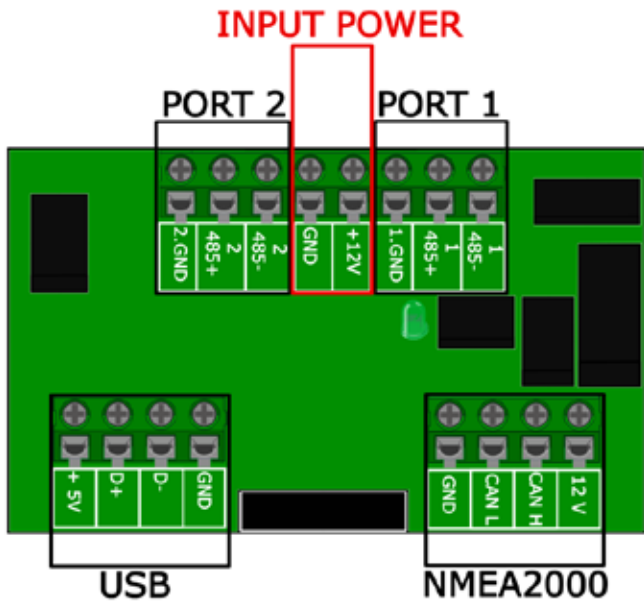

Main terminal pins:

- **PORT 2** : 2. GND, 2 485+, 2 485-
- **INPUT POWER** : GND, + 12V
- **PORT 1** : 1.GND ,1 485+,1 485-
- **USB** : +5V, D+, D-, GND
- **NMEA 2000** : GND, CAN L, CAN H, 12V

The NCP High-End is labeled with:

- **MAC**: Unique identifier number
- **SSID** : NCP wifi name
- **PASSWORD** : Password for Wifi connection
- **IP** : IP Address
- **DB ADDRESS** : Bluetooth direction address
- **0183 WIFI SERVER PORT**:0183 Wifi server port as per default
- **MOD**: NMEA Connect Plus High-End model.

```
MODEL: HIGH_END
MAC: B8:F0:09:92:16:B1
SSID: Nmea+B8:F0:09:92:16:B1
PASSWORD: 4fbfa71a08af
IP: 192.168.4.1
BLE: B8:F0:09:92:16:B2
N0183 WIFI PORT: 50000
```

4. Use cases.

4.1 How to display data from the NCP High-End via Wifi on PC Display from the Calypso Instruments Portable and Wired Ranges.

For those who are looking for displaying wind data on a second device.

To carry out this connection you will need to use a chart plotter. For this user case, we have used OPENCNP.

- Download OPENCNP or any other chart plot and run it.
- Open the OPENCNP and click on **options**.
- Once in options, click on **connections**, and **scroll** down the menu find the Add connection button. Click on **Add connection**.

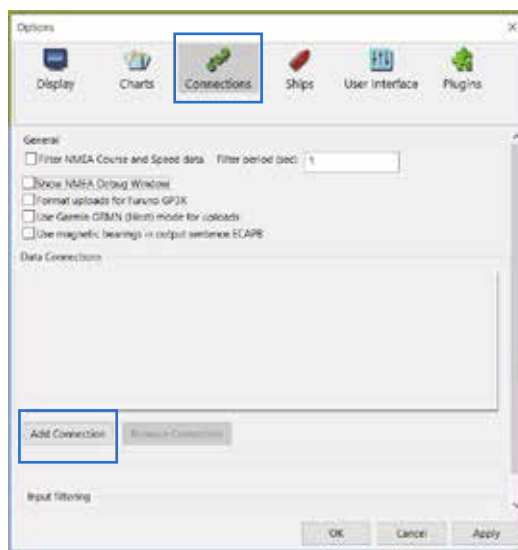

- Once in Add connection, click on **Network** and **TCP**.

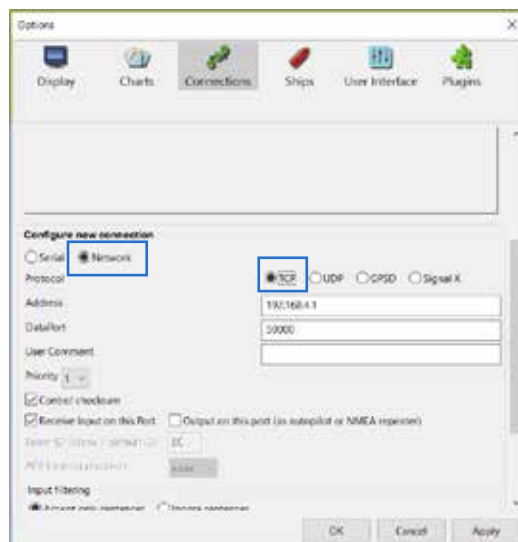

4. Use cases.

4.1 How to display data from the NCP High-End via Wifi on PC Display from the Calypso Instruments Portable and Wired Ranges (continuation).

- Type 192.168.4.1 in address field, which is the Ip address that you will find on the NCP High-End label.
- Input 50000 in the data port field. This is the wifi server port that you will find on your NCP High-End's label. If for any reason you have updated this number, input it in this field.
- Click on **Apply**.

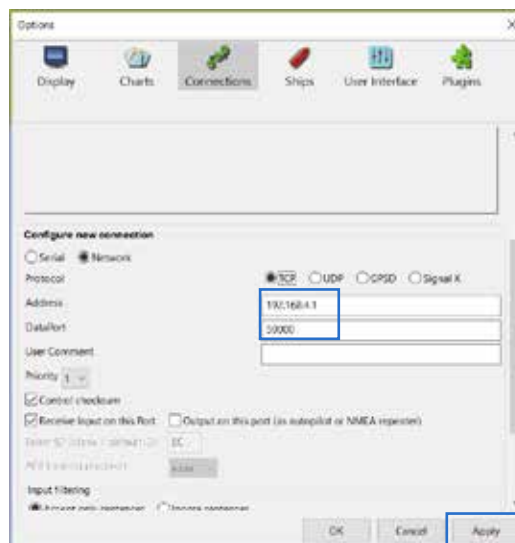

- In the next screen, make sure that the **Enable** checkbox is selected.
- Click **Ok**.

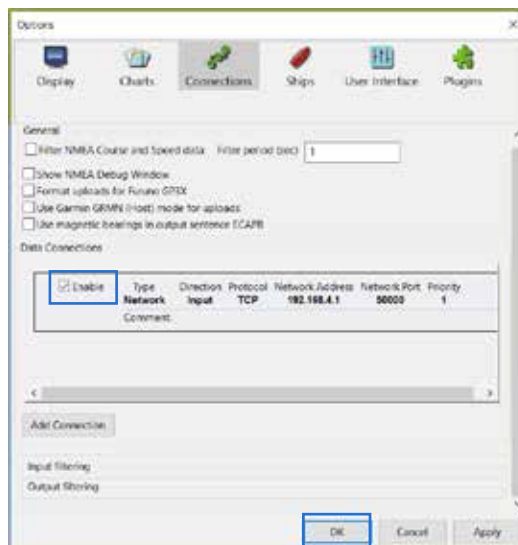

4. Use cases.

4.2 How to display data from the NCP High-End via Bluetooth or Wifi on Anemotracker App from the Calypso Instruments Portable and Wired Ranges.

For those who are looking for displaying wind data on a second device.

To carry out this connection you will need to use Anemotracker App, available for iOS and Android users.

You can visualize data from the NCP High-End via Bluetooth or via Wifi.

Visualization via Bluetooth

- Go to Anemotracker app from your mobile or tablet devices.
- In the main menu, press on **Pair Portable**.



4. Use cases.

4.2 How to display data from the NCP High-End via Bluetooth or Wifi on Anemotracker App from the Calypso Instruments Portable and Wired Ranges (continuation).

- in the available devices to pair, pair to the one called ULTRA NCP. That is your NCP. Press on that one to connect the unit.

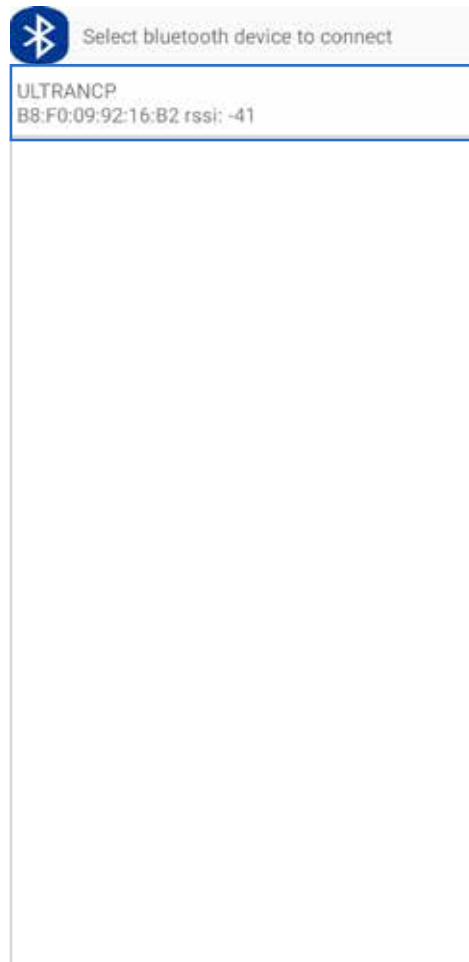

- Start receiving data in Anemotracker app.

4. Use cases.

4.2 How to display data from the NCP High-End via Bluetooth or Wifi on Anemotracker App from the Calypso Instruments Portable and Wired Ranges (continuation).

Visualization via WIFI (continuation)

- Connect the NCP to a power supply.
- From your computer, click on wi-fi and select the NMEA wifi network (it will always be named as NMEA+ a number and you can find it on your NCP-High-end label.).
- Type the wifi address that you will find on the NCP High-end label.
- Click on connect.
- Once connected, go to Anemotracker app, in your mobile or tablet devices.
- In the main menu, press on **Pair NCP**.

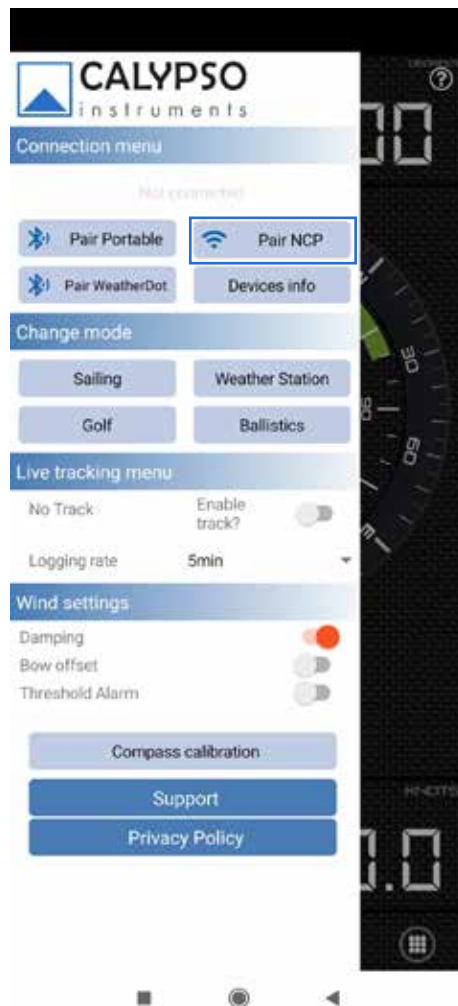

4. Use cases.

4.2 How to display data from the NCP High-End via Bluetooth or Wifi on Anemotracker App from the Calypso Instruments Portable and Wired Ranges (continuation).

Visualization via WIFI (continuation)

- In the Server address field, type 192.168.4.1. on ip address . You will find it on the NCP High-End's label.
- In the server port field, type 50000. This is the wifi server port that you will find on your NCP High-End's label. If , for any reason, you have updated this number, input it in this field.

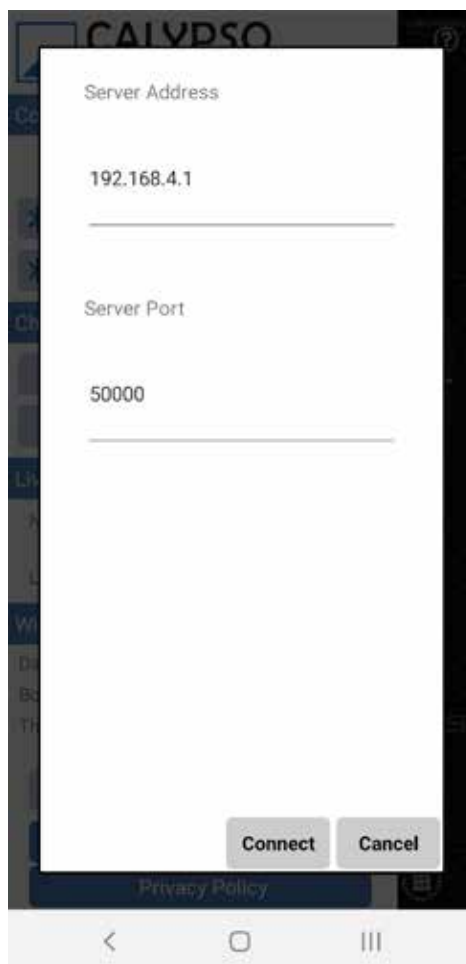

- Start receiving data in Anemotracker app.

4. Use cases.

4.2 How to display data from the NCP High-End via NMEA 2000 cable on the Raymarine display from the Calypso Instruments Portable and Wired Ranges.

For those who are looking for displaying wind data on a second device. To carry out this connection you need to use a Raymarine display. In this case, we are using an **AXIOM 9 RV** Raymarine display.

- Once in the Raymarine dashboard, press on **Settings**.

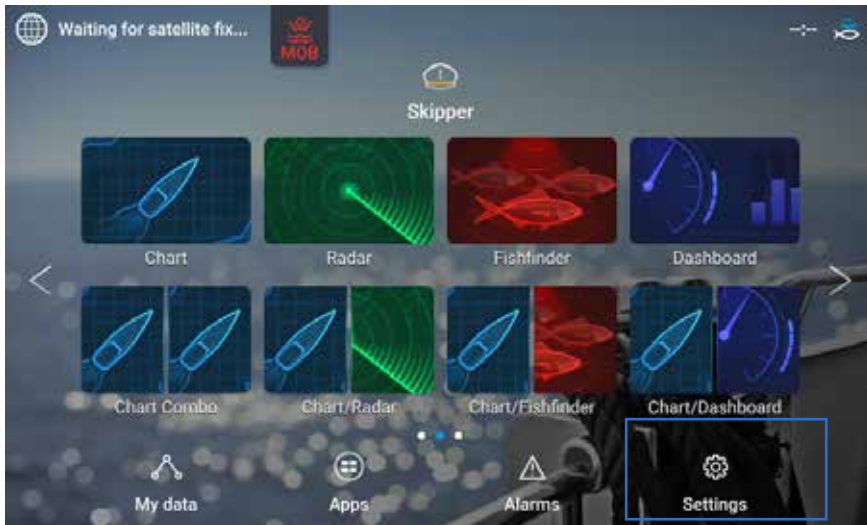

- Once in settings, press on **Network**. Make sure your NCP High-End appears in this section as it means it is connected. If for some reason you don't see it, it means the NCP High-End is not being detected by the Raymarine display. Please double check your connection. If the issue persists, contact us at sales@calypsoinstruments.com.

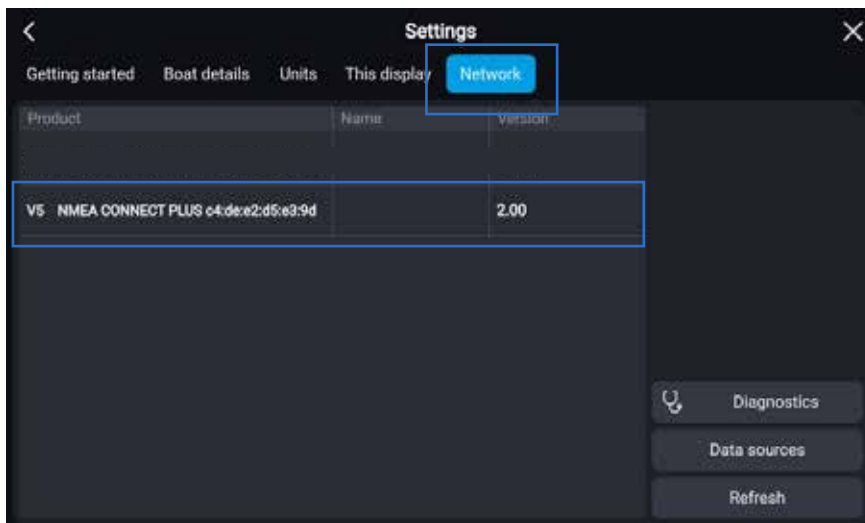

4. Use cases.

4.2 How to display data from the NCP High-End via NMEA 2000 cable on the Raymarine display from the Calypso Instruments Portable and Wired Ranges.

- Go back to *Dashboard*. Start reading wind data.



- If, for some reason, you don't see a zero data in your dashboard, it means that the NCP High-End is connected but it is not receiving data from the wind meter. In this case, please double check the wind meters' connection. If you see nothing (please see picture below), it means the NCP High-End is not well connected. Please, double check the connection. If the issue persists please contact us at sales@calypsoinstruments.com.



4. Use cases.

4.2 How to display data from the NCP High-End via NMEA 2000 cable on the B&G display from the Calypso Instruments Portable and Wired Ranges.

For those who are looking for displaying wind data on a second device. To carry out this connection you need to use a B&G display. In this case, we are using a **TRITON 2** B&G display.

- Once in the B&G dashboard, press on **Settings**. Scroll down and select **System**.



- Once in system, select **Network**.



4. Use cases.

4.2 How to display data from the NCP High-End via NMEA 2000 cable on the B&G display from the Calypso Instruments Portable and Wired Ranges.

- In network, select **Sources**.



- In sources, click on **Auto Select**.



4. Use cases.

4.2 How to display data from the NCP High-End via NMEA 2000 cable on the B&G display from the Calypso Instruments Portable and Wired Ranges.

- Once in autoselect, press on **Start**.



- A progress bar will be shown to let you know it is looking for devices connected to the NMEA 2000 network. In this picture below, the B&G is recognizing the NCP High-End. If you B&B display does not recognize your NCP High-End please double check the connection. If the issue persists, contact us at sales@calypsoinstruments.com.



4. User cases.

4.2 How to display data from the NCP High-End via NMEA 2000 cable on the B&G display from the Calypso Instruments Portable and Wired Ranges.

- As soon as the search is completed, press on **Close**.



- Go back to **Dashboard**. Start receiving wind data. If you don't receive data please double check the connection. If the issue persists, please contact us at sales@calypsoinstruments.com



4. Use cases.

4.2 How to display data from the NCP High-End via NMEA 2000 cable on the Humminbird display from the Calypso Instruments Portable and Wired Ranges.

For those who are looking for displaying wind data on a second device. To carry out this connection you need to use a Humminbird display. In this case, we are using a **SOLIX 10MDI G2 CHO** Humminbird display.

- Once in the Humminbird dashboard, press on **Settings**.

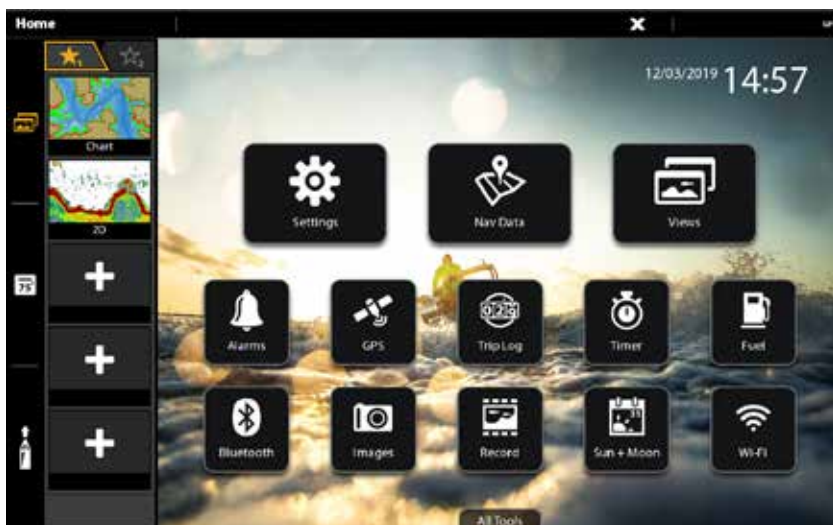

- Once in settings, go to **Network** and select **Data Sources**.

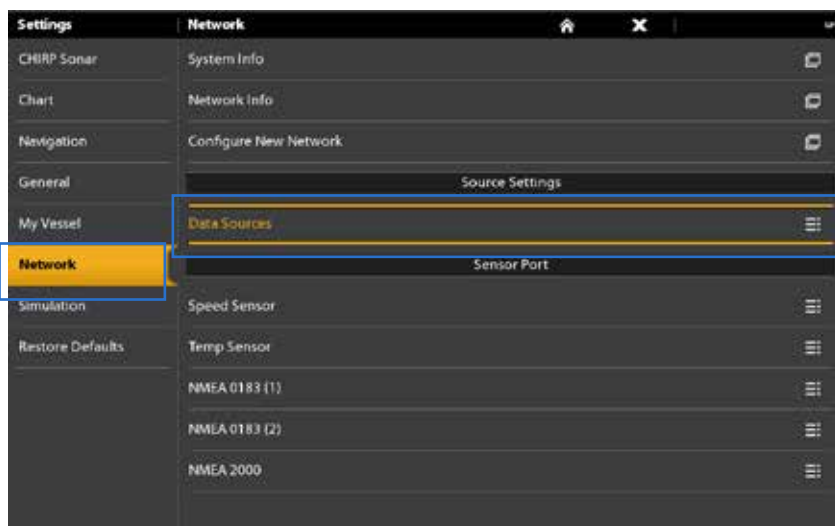

4. Use cases.

4.2 How to display data from the NCP High-End via NMEA 2000 cable on the Humminbird display from the Calypso Instruments Portable and Wired Ranges.

- One in data sources, press on **Wind Speed & Direction**.

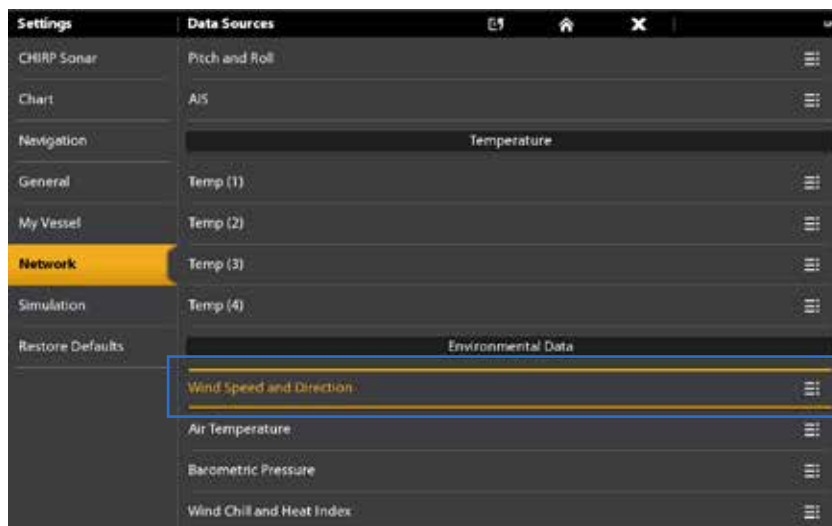

- Make sure the NCP High-End shows up there. Select the NCP High-End to make sure your NCP High-End wireless recognizes your NCP High-End. If it doesn't, please double check your connection. If the issue persists, contact us at sales@calypsoinstruments.com.

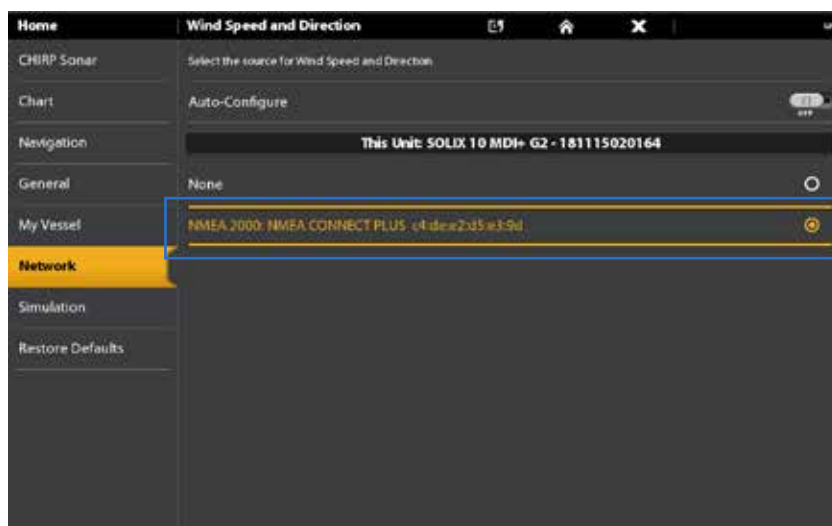

4. Use cases.

4.2 How to display data from the NCP High-End via NMEA 2000 cable on the Humminbird display from the Calypso Instruments Portable and Wired Ranges.

- Go back to dashboard. Start receiving wind data.

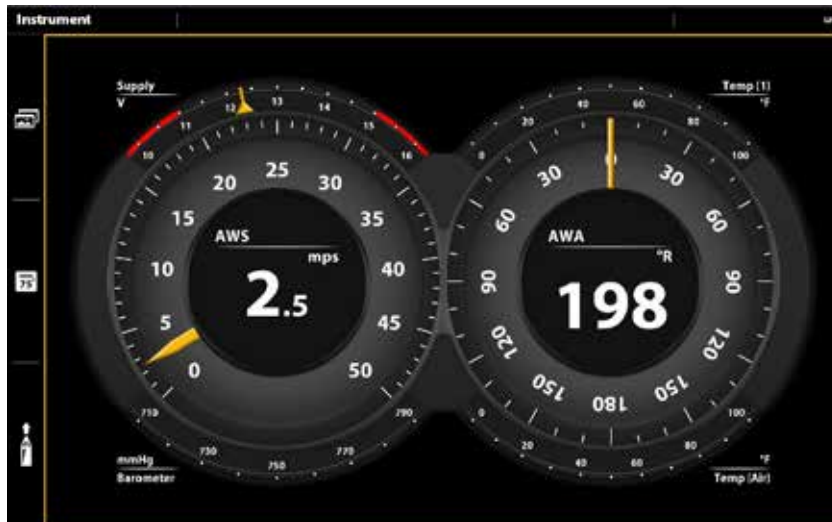



NMEA CONNECT PLUS HIGH-END

User manual English version 1.0

01.05.2023